



Bluetooth CABINET LOCK

BLE-51

1. Overview.....	2
2. General started	2
3. Register	3
4. Homepage Introduction	4
5. Add lock	5
6. Details of the lock	6
7. Device record	7
8. Add friends.....	8
9. How to give access right to user.....	9
10. Personal center.....	10

Overview

Congratulations!!

On buying AURUS BLE - 52 B

This lock can be installed in drawers and cabinets. The AURUS BLE – 51 has a built in Cr 800mAH 3v battery which should last you 8-10 months.

When the Battery Low warning will appear on your app you are required to change the batteries immediately.

You can have several locks in your house and control them with the app. The Max distance between the app & smartphone should be 15 ft.

Registration is very easy. And the 1st person to register the lock is the master. The master can grant & cancel access rights of a lock to any other user.

There can be only 1 master.

The master can grant access right remotely to another user via the internet, For example if you are travelling and want to grant access to the user at your home/office you can easily do so in a minute.

Getting Started

Please install the mobile app: - "OKLOK"

Please search "OKLOK" in Google
Playstore (Android) or APP store (IOS)
to download the APP



Please note: - The Bluetooth must remain on while using the app and the lock.

How to Install

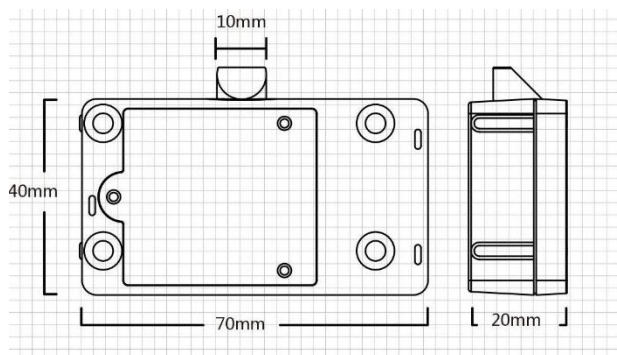

Battery Type :-

They battery used in the locks is Cr 800mAh 3v.



urus

Register

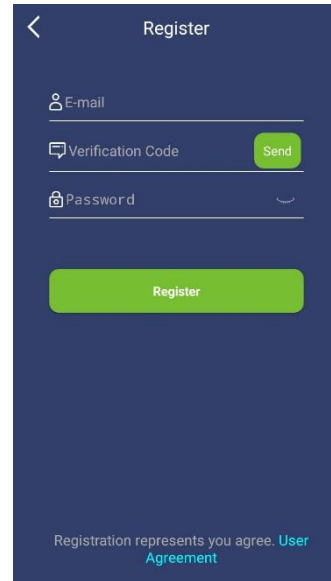
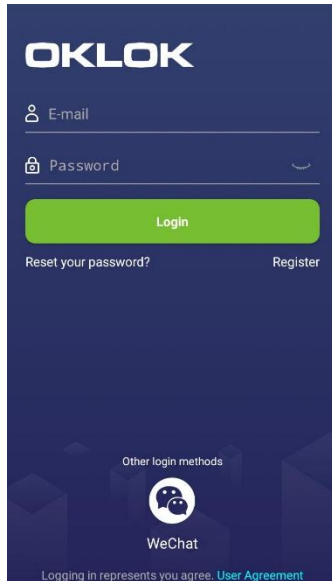

Use E-mail Address to register.

1. Click Register
2. Input you Email address
3. Click Send for the verification code to be received via email.
4. Input the verification code received on your given email-id.
5. Set a Password
6. Login

HOMEPAGE INTRODUCTION

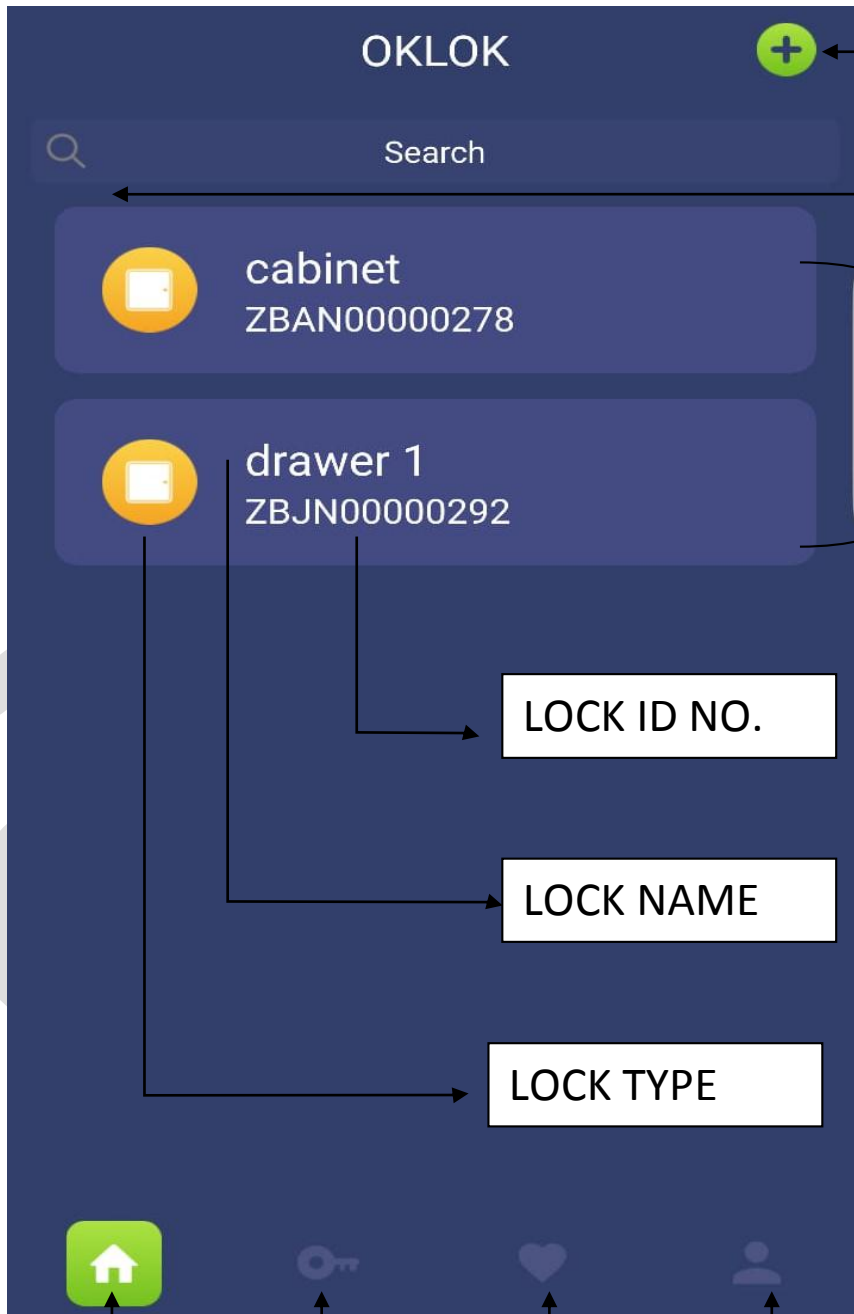

Add lock

Search locks by ID number or Lock Name.

List of locks
Click to find the lock details

LOCK ID NO.

LOCK NAME

LOCK TYPE

HOMEPAGE

DEVICE RECORD

MY FRIENDS

PERSONAL CENTER

Add Lock: +



Click on Add lock

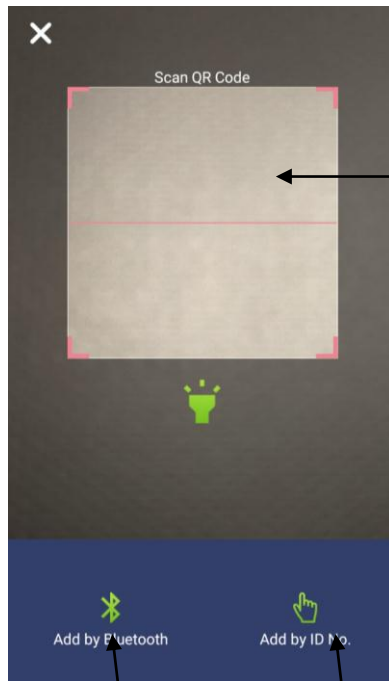

To add by QR code, scan the QR code here. (sticker provided with lock)

To search by Bluetooth and add. Click Here.

To enter the ID no. and add. Click Here.

Details of the lock

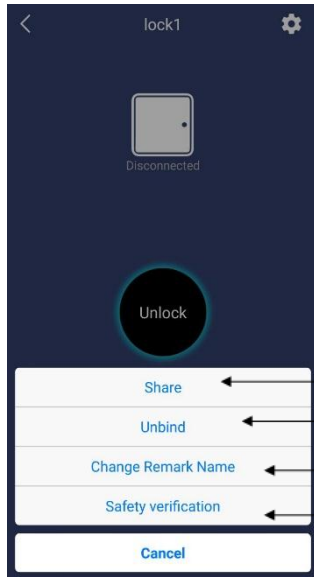

Share APP

Will delete the lock from the app.

Will change the name of the lock.

To add the level of security for the lock.

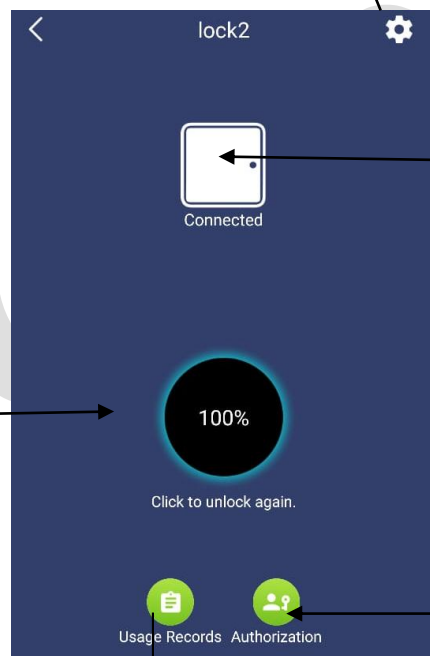

Connection Status

Battery Power Status

Friends/Family must be added in the friends list before authorization.

Unlocking record & sharing record

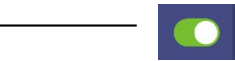
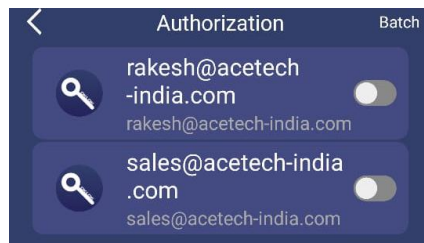
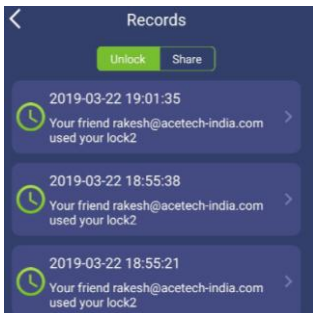

Click to authorize

Device Record:



CLICK HERE

Usage records

Share records

To know who asked for access right

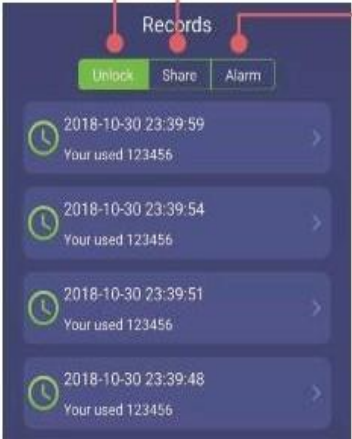

aurus

Add Friends:



The friend to be added should download the app and register an account.

1.



2.



3.

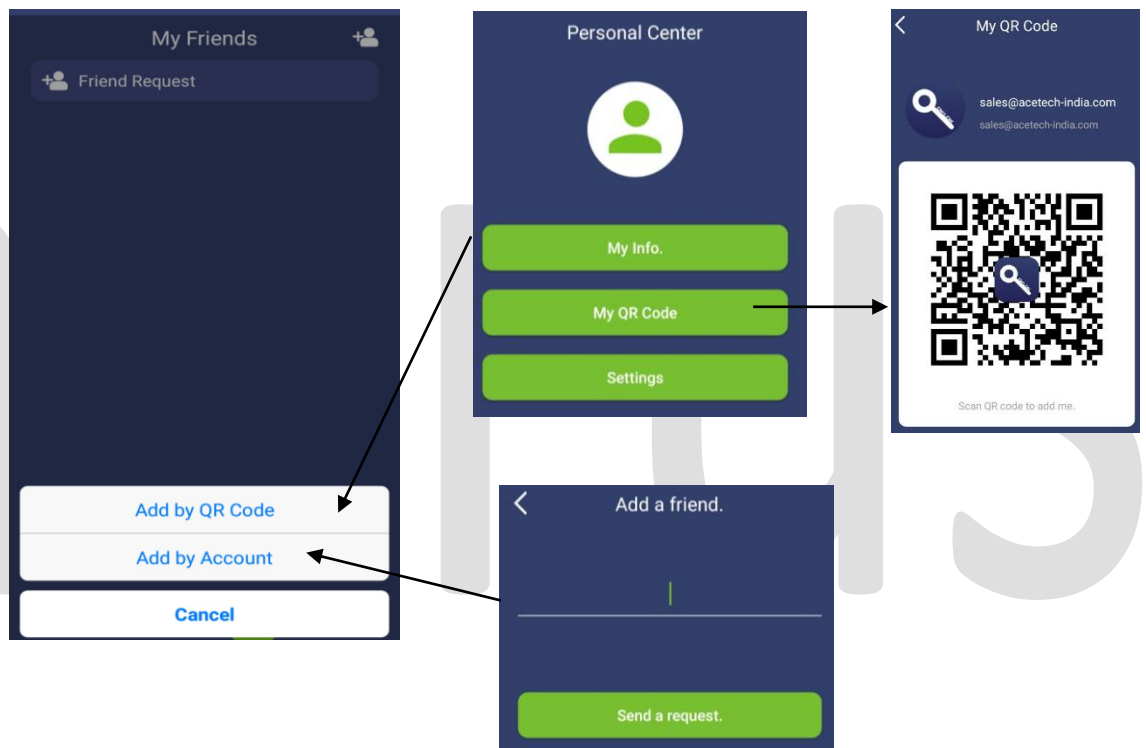

4. Send the friend request by any one method stated above.

5.

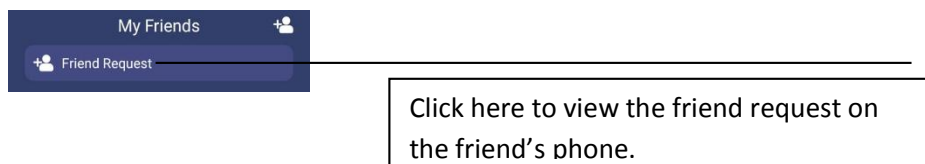

6.

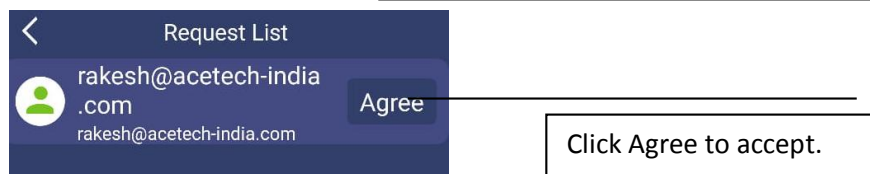

7. You will be able to see each other in friends list.

8. You have successfully added a friends.

HOW TO GIVE ACCESS RIGHT TO A USER

1. The person must be added as your friend
2. Go to “my friends”
3. Click on the friend you need to give access to.
4. Click on “Authorization”
5. Swipe the button on the right to give access of that particular lock.

Or

You can also go the lock you want to give access to and then click on “authorization” and give access.

aurus

Personal center:

